

境界ブロック

片面歩車道境界ブロック

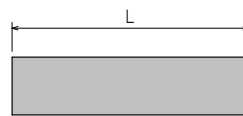
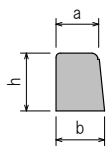
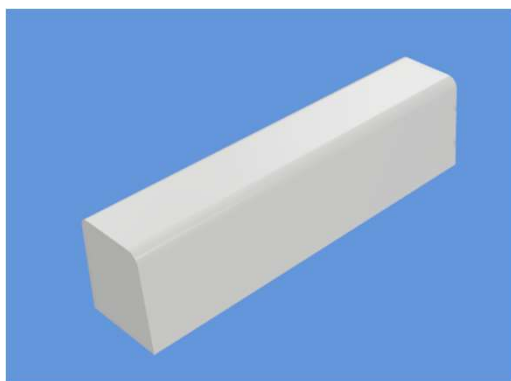

種類・略号・呼び	参考重量 (kg)	寸法 (mm)					
		a	b	h	R	R'	L
片面歩車道境界ブロック片B	110	180	205	250	30	20	1000

○基本

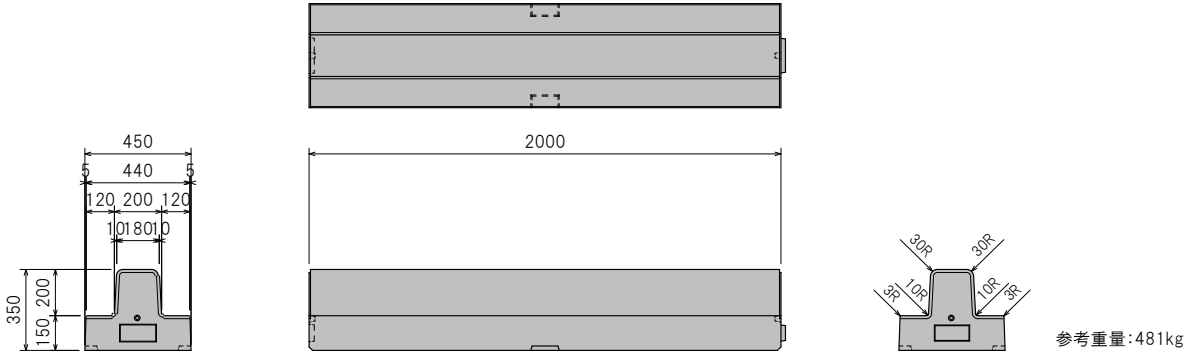

○水抜き

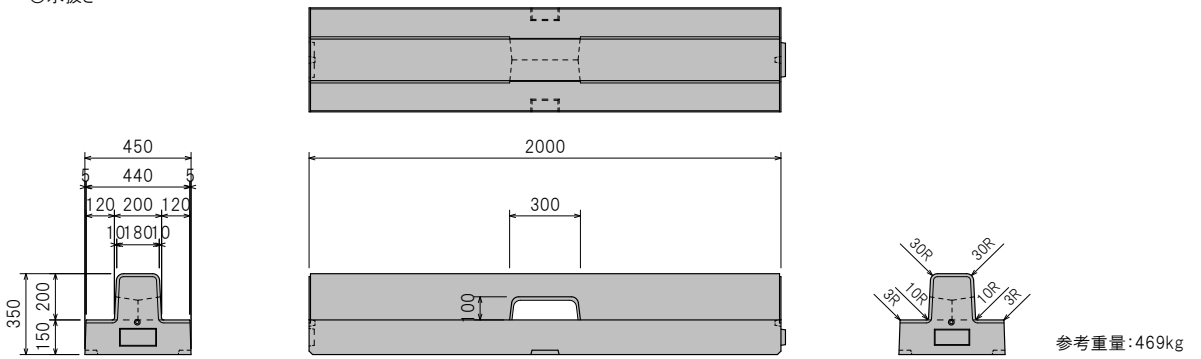

○斜

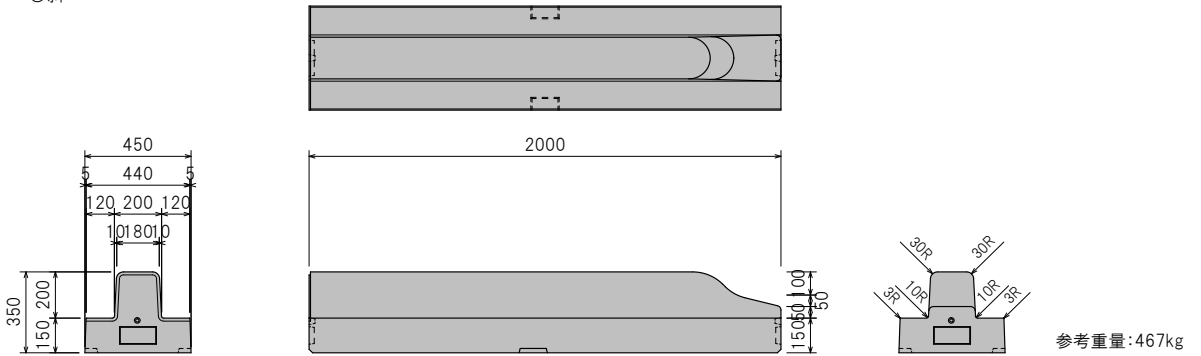

○水抜き斜

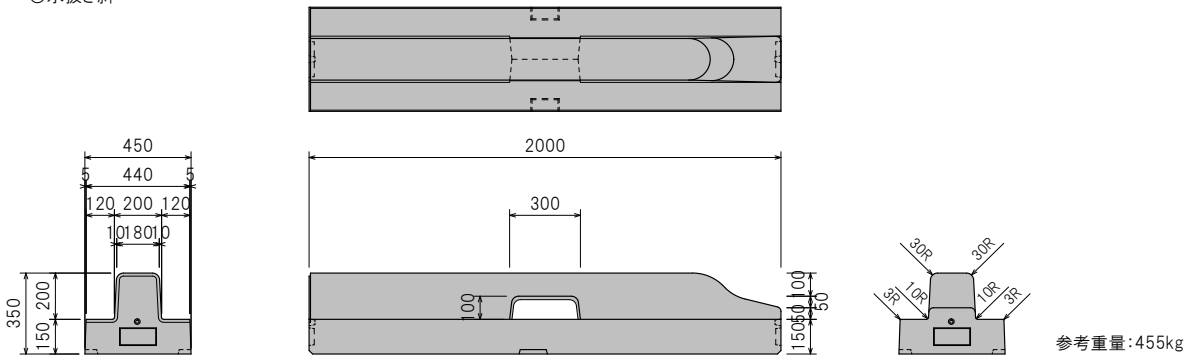

境界
ブロック

C型エプロン両面R

○直

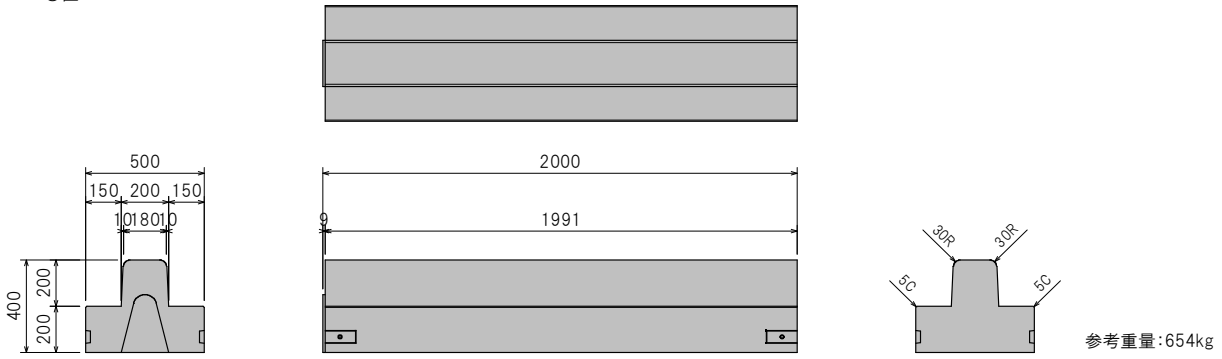

○端末

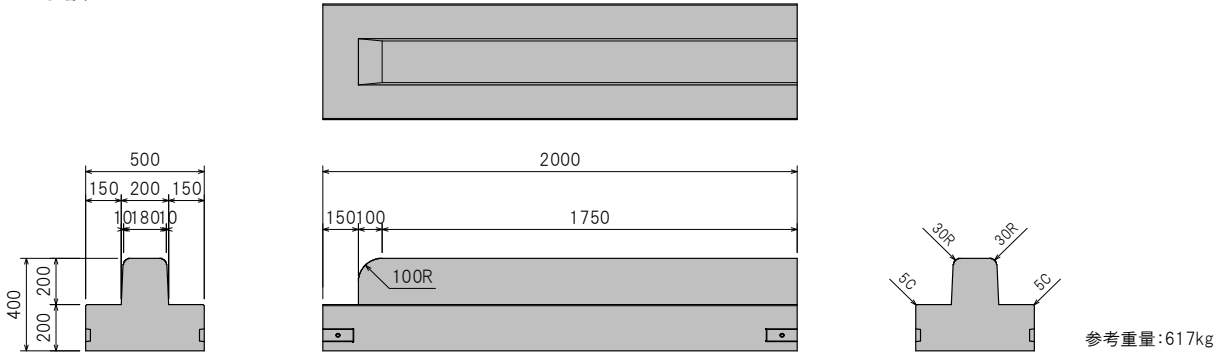

C型エプロンマウンドアップ LC両R

○直

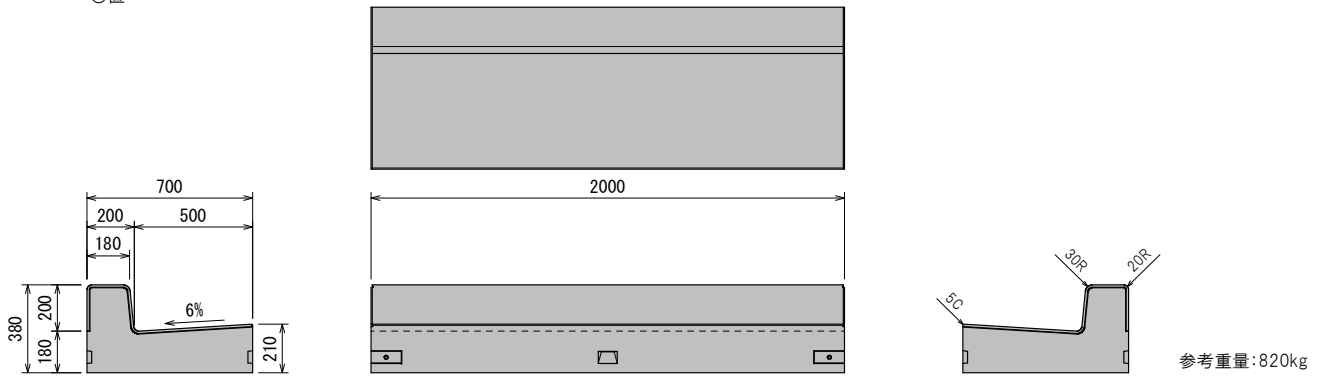

○切下平

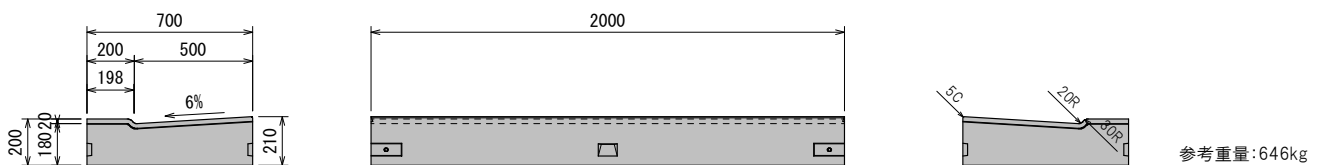

○左右切下

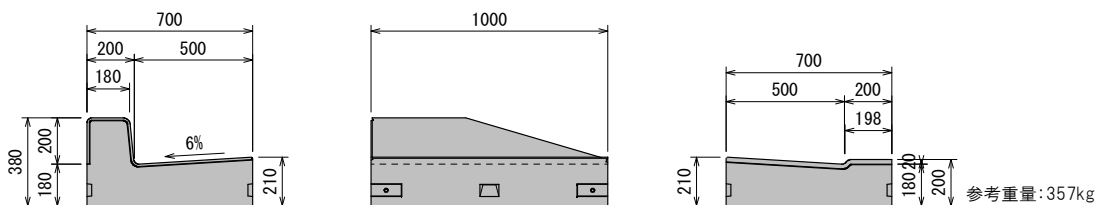

※水抜きタイプ、セミフラット水抜きタイプ、ブロック片面Rタイプも製造可能です。

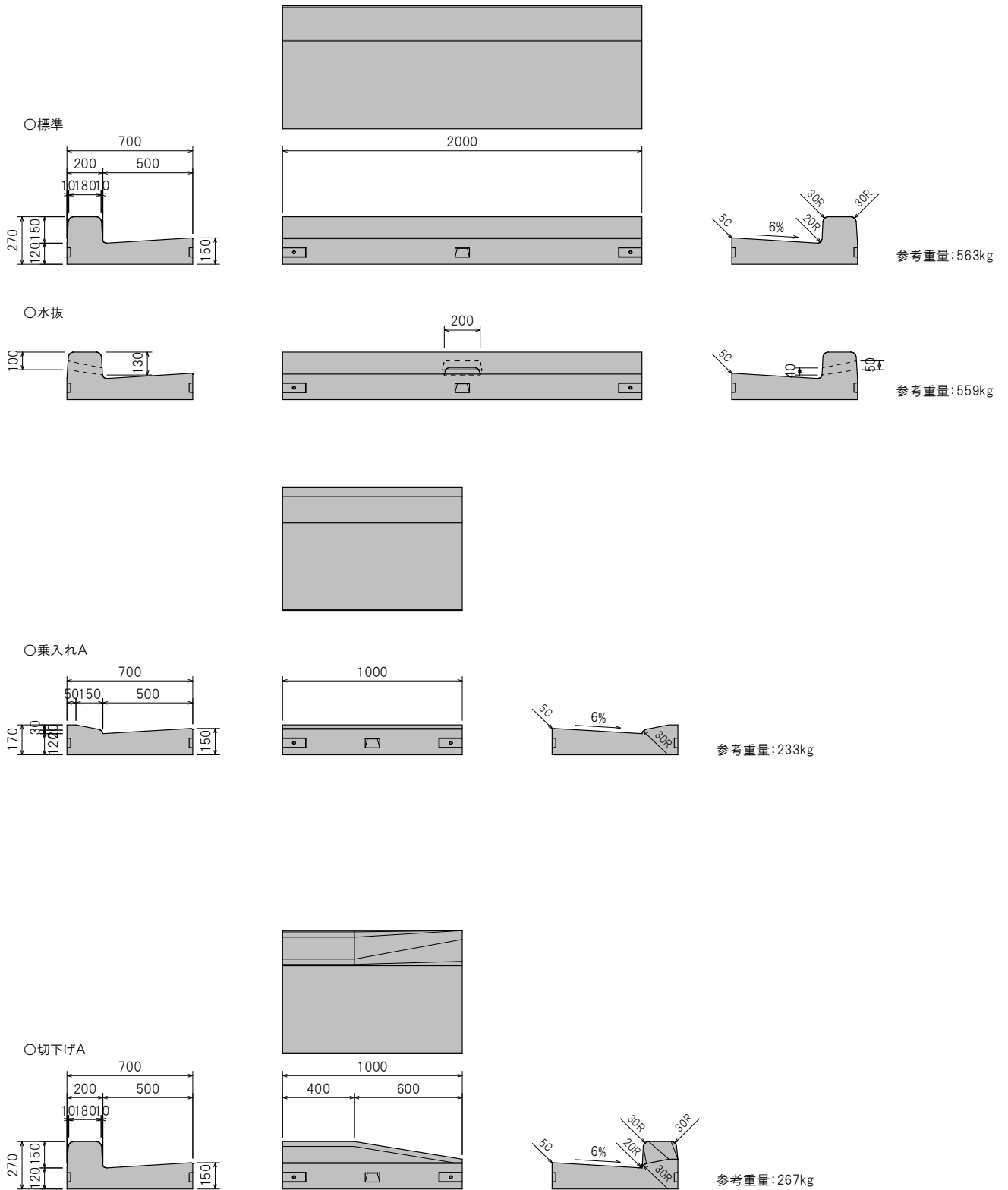

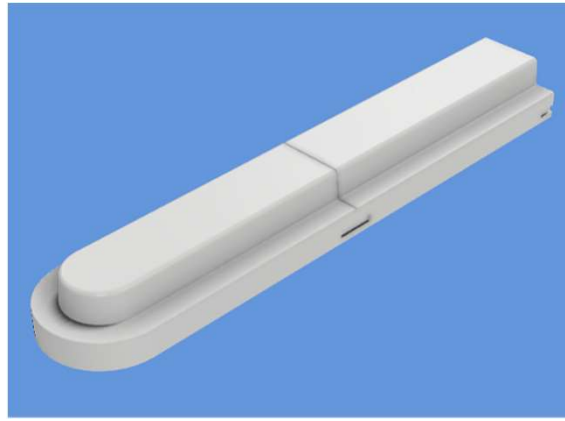

○標準

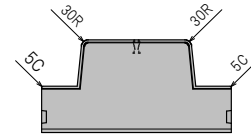
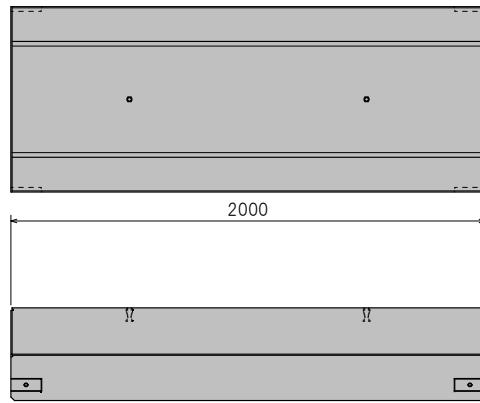
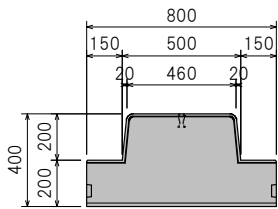

参考重量: 1175kg

○端末

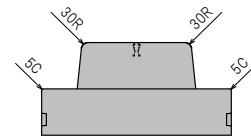
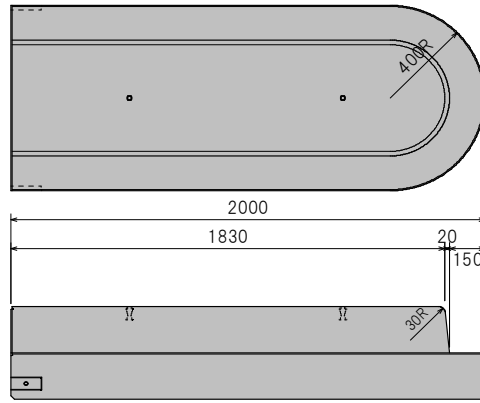
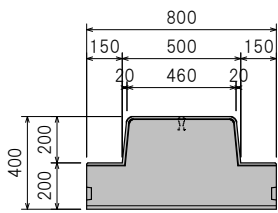

参考重量: 1097kg

○シフト分割タイプ

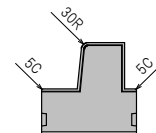
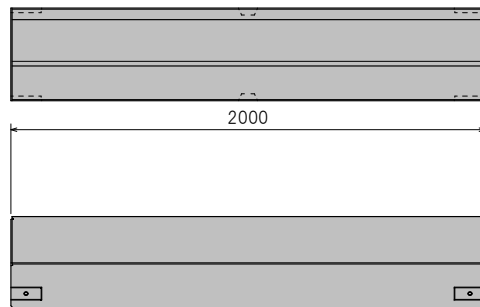
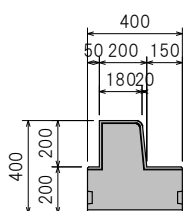

参考重量: 541kg

○標準

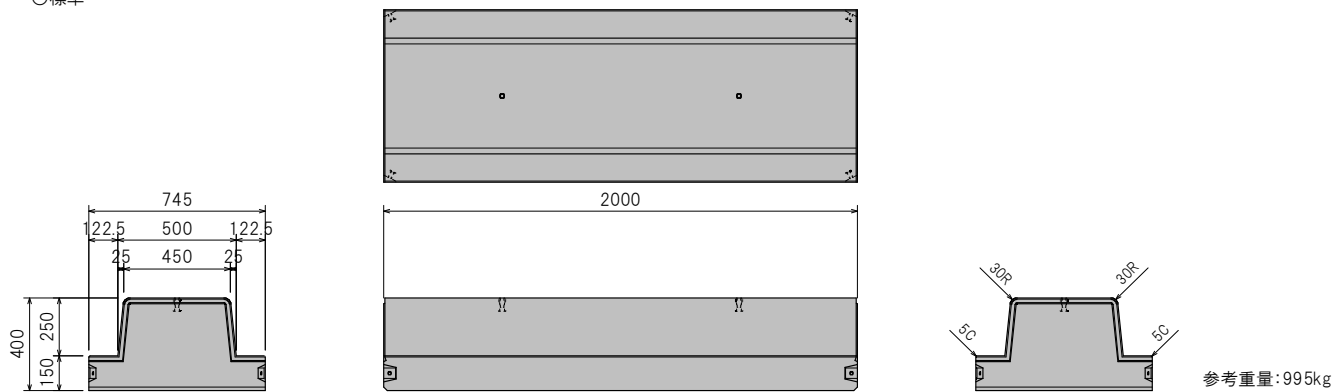

○水抜

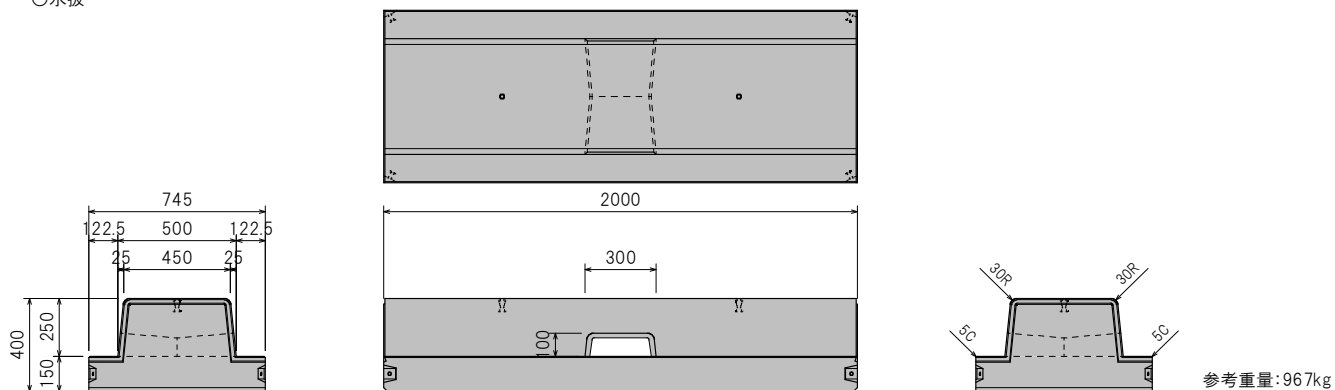

○端末

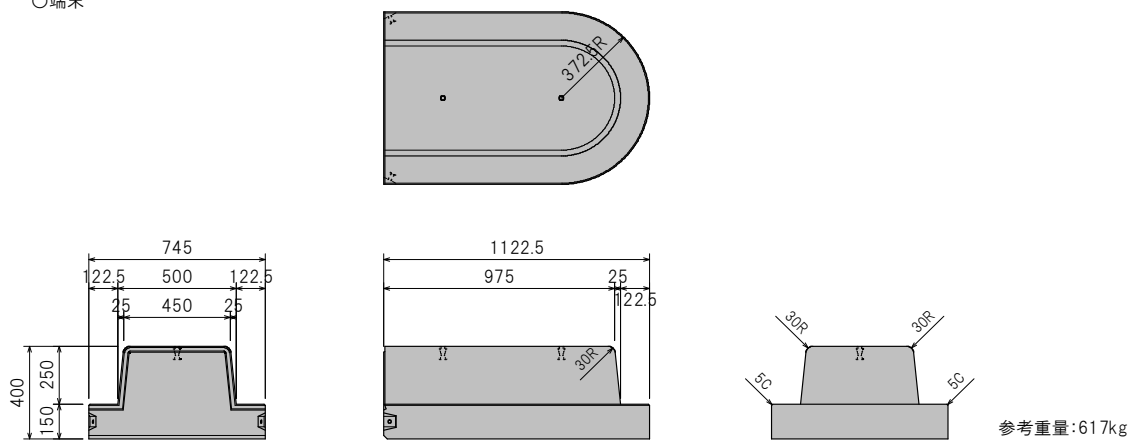

○シフト分割タイプ 標準 (分割)

